



## FIRST TIME INSTALLATION

\* REMOVE PARTS FROM INSIDE THE PACKAGE AND CHECK THEM ALL

\* CONTACT YOUR DEALER IF ANY PART IS MISSING OR DAMAGED

\* USE THE EQUIPMENT SPECIFIED FOR INSTALLATION

### ASSEMBLY INSTRUCTIONS (ROOF RACK)

Product Code: MC02003

### COMPATIBLE VEHICLES

HND CRV (MK5) SUV 12-18/19+  
CADL XT5 SUV 16+

### PACKAGE INCLUDED

1-	TURTLE AIR 2 CHASSIS	4
2-	NO.5 ALLEN WRENCH	1
3-	CLOTH KEYCHAIN	1
4-	C9	4
5-	2003 PLASTIC PART	4
6-	M6x35 INBUS BOLT	4
7-	M6 1/2 WASHER	4
8-	M6x20 INBUS BOLT	8
9-	M6 WASHER	8
10-	M6 SPEEDNUT	4

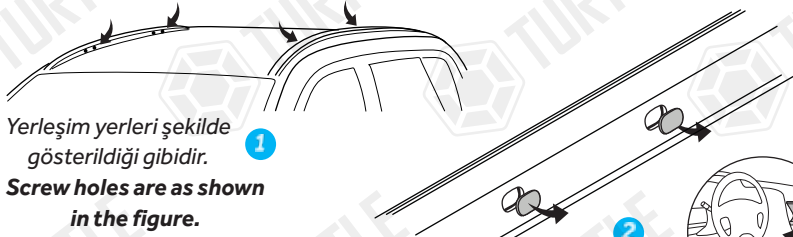

Yerleşim yerleri şekilde gösterildiği gibidir.  
Screw holes are as shown in the figure.

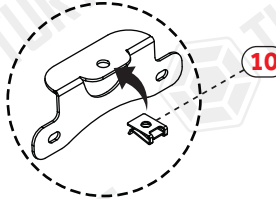

Çıta üzerindeki koruyucu kapakları çıkartıp demonte için saklayınız.  
Remove the rail's original cover caps.  
You must keep them for disassembly.



SCAN ME FOR INSTALLATION VIDEO

Klipsi metal demirin üst kısmına yerleştiriniz.  
Place the clips top of the metal bracket.

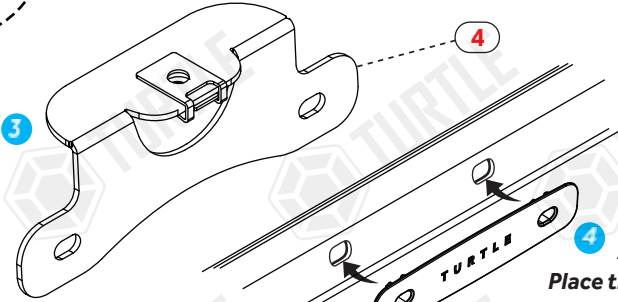

Plastik parçayı çitanın iç yüzeyine yerleştiriniz.  
Place the plastic part on the inner surface of the rail.

Place the plastic part on the inner surface of the rail.

MAX 5NM

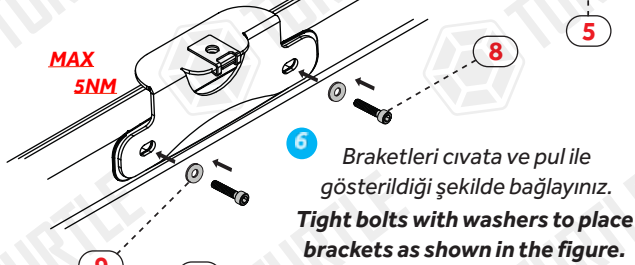

Braketleri cıvata ve pul ile gösterildiği şekilde bağlayınız.  
Tighten bolts with washers to place brackets as shown in the figure.

Metal braketlerin yönü şekilde gösterildiği gibidir.  
Metal brackets have to place as shown in the figure.

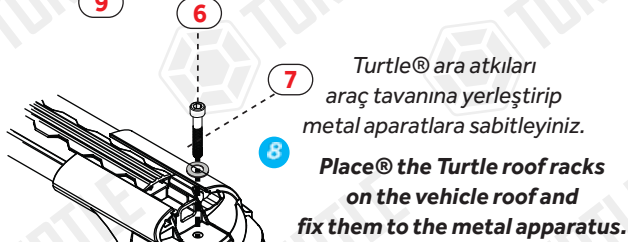

Turtle® ara atıkları araç tavanına yerleştirip metal aparatlara sabitleyiniz.  
Place® the Turtle roof racks on the vehicle roof and fix them to the metal apparatus.

MAX 5NM

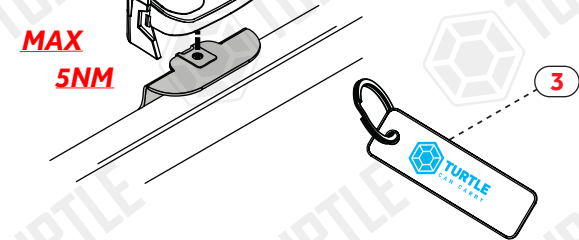

Profilleri ortaldıktan sonra yatay sabitleme cıvatalarını sıkınız.  
After centering the profiles, tighten the horizontal fixing bolts.

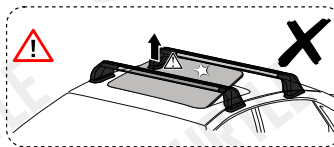

80 Km/h  
50 Mph

130 Km/h  
80 Mph

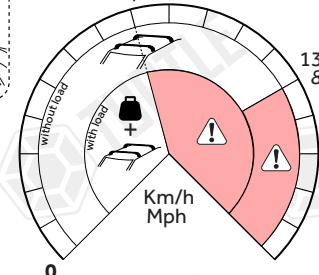

Max. Load  
75 kg

\* Kullanım amacı: Aracın bagajı yeterli olmadığı durumlarda araç tavanında yük ve eşya taşımak.

\* Purpose of usage: Carrying cargo and goods on the vehicle's roof when the vehicle's trunk is not sufficient.